



BLINDS
TO GO®

Harmony Drapery Collection Pleated Installation Guide

LE MARCHÉ
DU STORE™

Collection de rideaux Harmonie
Guide d'installation de rideaux plissés

Colección de cortinas Harmony
Guía de plisadas de cortinas

WARNING

STRANGULATION HAZARD: Young children can be strangled by cords. Immediately remove this product if a cord longer than 22cm or a loop exceeding 44 cm around becomes accessible.

MISE EN GARDE

RISQUE D'ÉTRANGLEMENT : Les enfants en bas âge peuvent s'étrangler avec des cordes. Enlevez immédiatement ce produit si une corde mesurant plus de 22 cm devient accessible ou si le contour d'une boucle de plus de 44 cm devient accessible.

Mounting options

Inside mount: Blind is mounted inside the window frame.

Outside mount: Blind is mounted either on or outside the window frame.

Note: Mounting screws provided are suitable for most mounting surfaces. See below for additional suggestions.

For wallboard or plaster: Use hollow wall anchors for added support.

For concrete, stone, brick or tile: Use an appropriate drill bit and appropriate anchors before fastening the screws.

For metal surfaces: Pre-drill holes before fastening the screws.

Options d'installation

Installation à l'intérieur du cadrage : Le store est installé à l'intérieur du cadrage.

Installation à l'extérieur du cadrage : Le store est installé sur ou à l'extérieur du cadrage.

Avis : Les vis fournies peuvent être utilisées pour l'installation sur la plupart des surfaces. Voici quelques conseils s'appliquant à certains types de surfaces.

Pour les panneaux de gypse ou le plâtre : Utilisez les chevilles d'ancrage (fournies) pour obtenir un support additionnel.

Pour le béton, la pierre, la brique ou la céramique : Utilisez une perceuse avec des mèches appropriées de même que les chevilles d'ancrage appropriées avant de poser les vis.

Pour les surfaces métalliques : Percez des trous avant de poser les vis.

Opciones de instalación

Montaje interior: La persiana es montada dentro del marco de ventana.

Montaje exterior: La persiana es montada fuera del marco de la ventana.

Nota: Los tornillos de montaje provistos son adecuados para la mayoría de las superficies. Para notas adicionales vea a continuación.

Para paredes de cartón o de yeso: Utilice anclajes de pared hueca (incluidos) para soporte adicional.

Para concreto, piedra, ladrillo o cerámica: Use una broca adecuada y anclajes adecuados antes de fijar los tornillos.

Para superficies metálicas: Taladre orificios antes de fijar los tornillos.

Tools Suggested,
Outils suggérés,
Herramientas
recomendadas

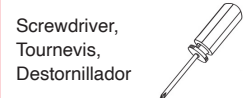
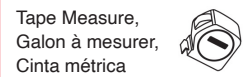

1/8 po mèche
« Phillips »

Parts / Pièces / Piezas



Ceiling Mount Bracket

Support de fixation au
plafond

Soporte para montaje
en techo

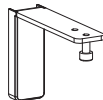

Wall Mount Bracket

Support de fixation
mural

Soporte para montaje
en pared



Screws & Anchors

Quantity: 2 each per bracket

Vis & chevilles

Quantité : 2 pour chacun des supports

Tornillos y Anclajes

Cantidad: 2 de cada uno por soporte

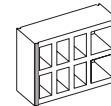

OPTIONAL: Spacer Blocks

Quantity: 1 per bracket

En option: Blocs d'espacement

Quantité : 1 par support

OPCIONAL: Bloques de espaciamento

Cantidad: 1 por soporte

Mounting / Montage / Montaje

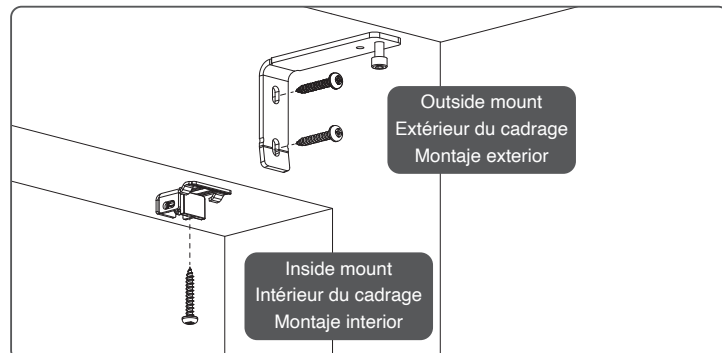
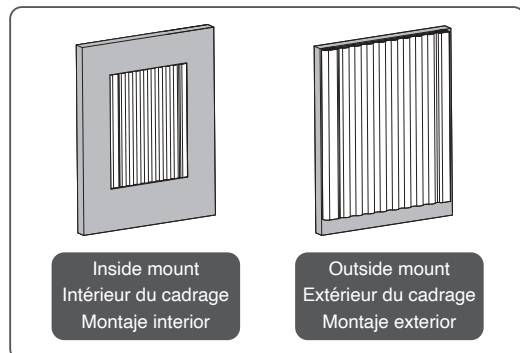

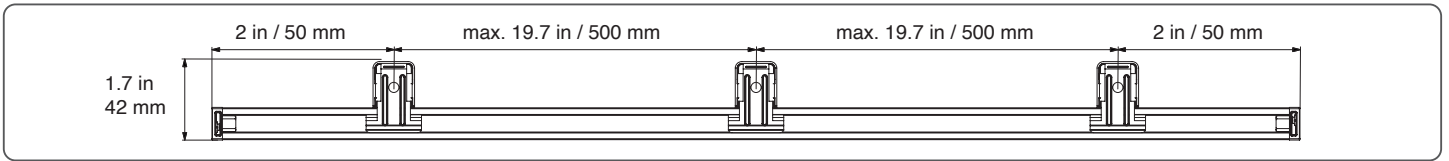

Installation / Installation / Instalación

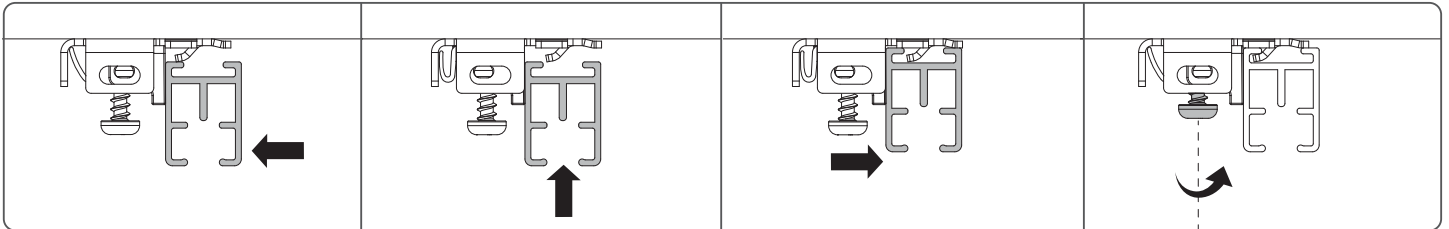
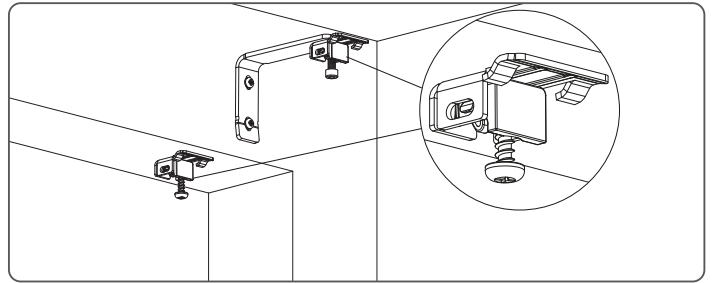
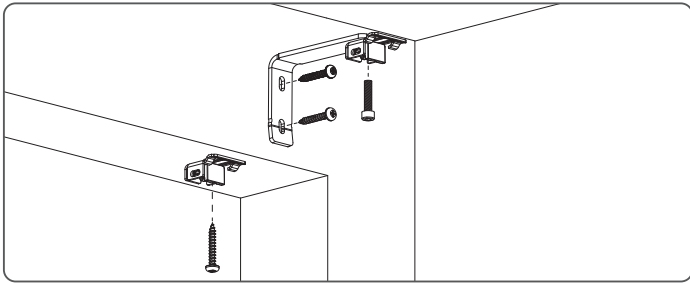

One Way Pleated - Single Panel
 Rideaux à plis à sens unique - Panneau unique
 Plisado unidireccional - Panel único

Center Opening Pleated - Paired Panels
 Rideaux à plis à ouverture centrale - Panneaux jumelés
 Apertura central plisada - Paneles emparejados

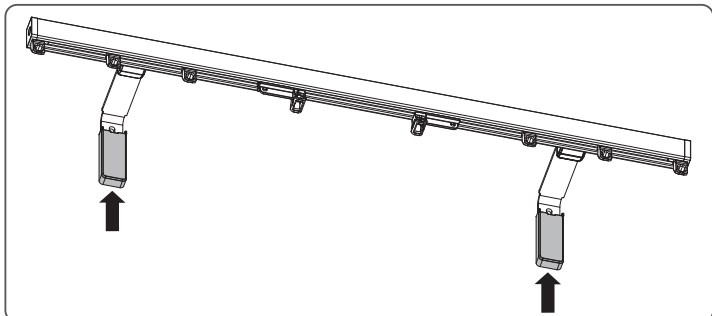
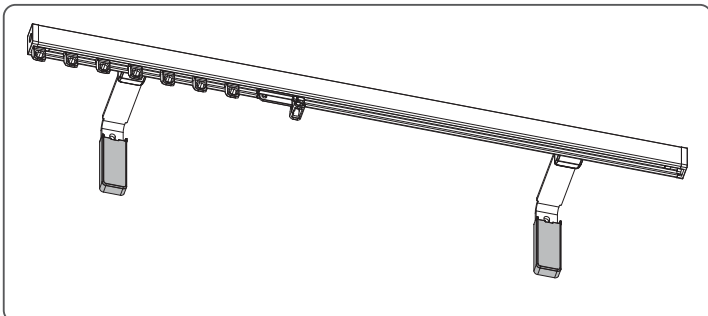
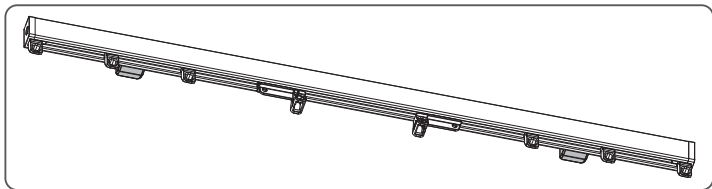
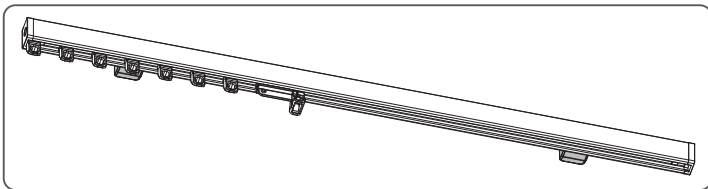
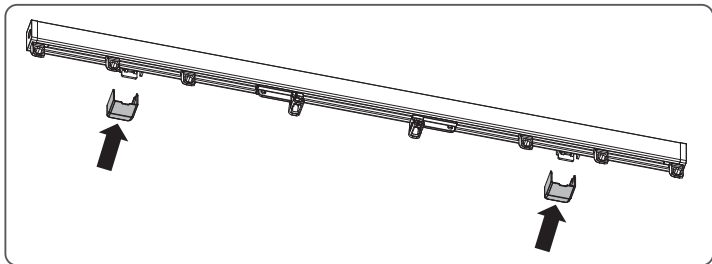
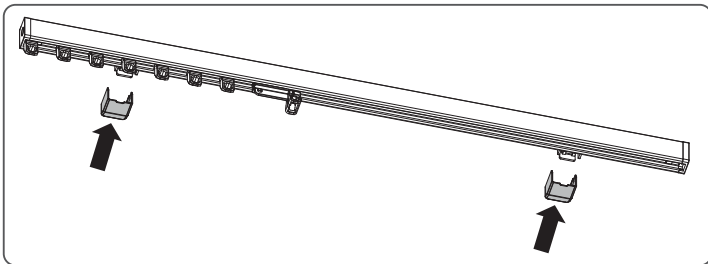
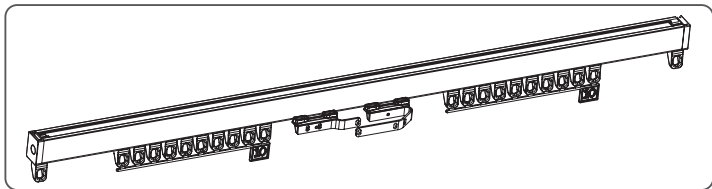
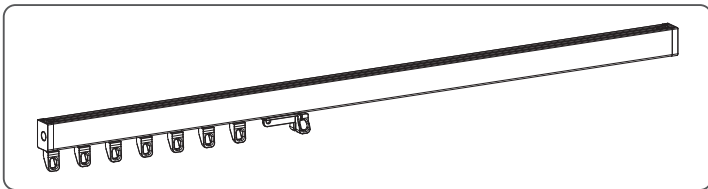

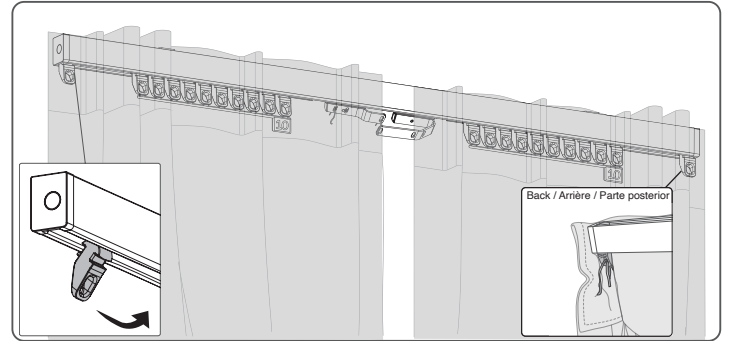
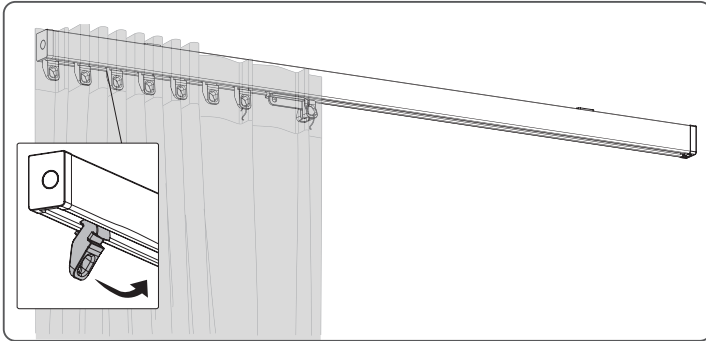
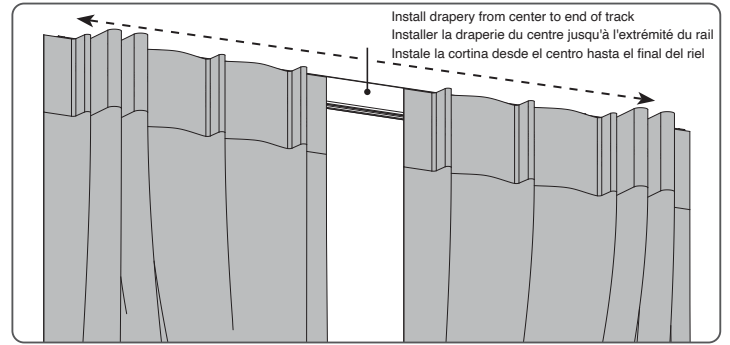
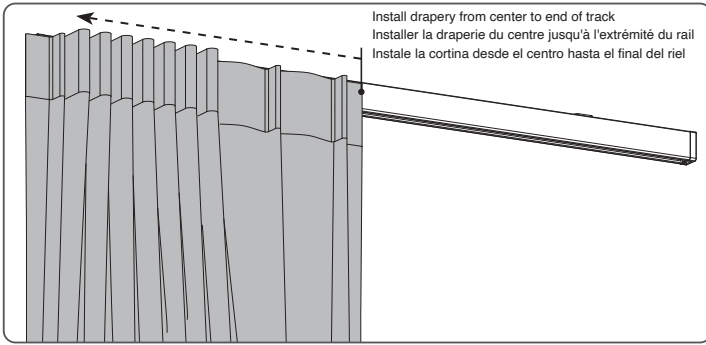

Breaking Buckram / Séparateur / Plisar el Bucaram

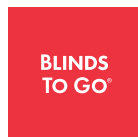
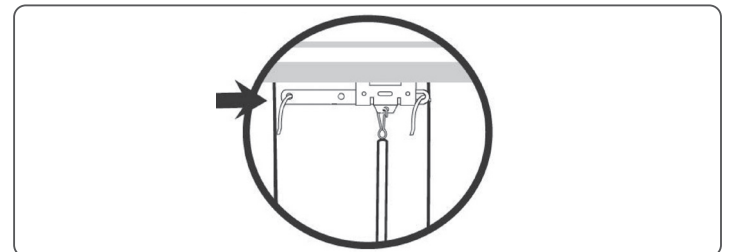
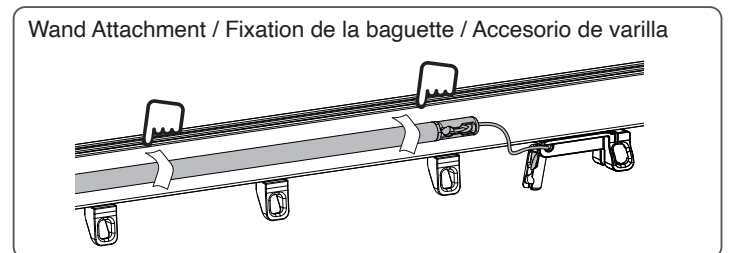
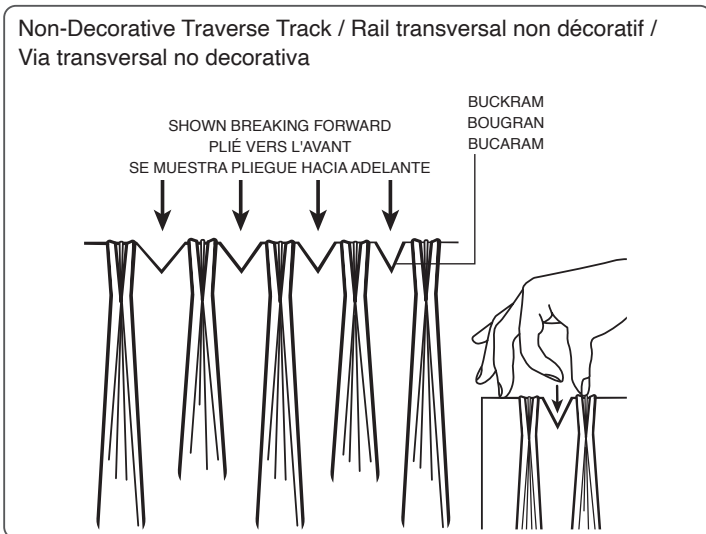

US TRAINING AND DEVELOPMENT CENTER

101 East State Route 4
Paramus, New Jersey, USA
07652

www.blindstogo.com



CANADIAN STORE AND SUPPORT CENTER

3510 St-Joseph Blvd. East
Montreal, Quebec, Canada
H1X 1W6

CENTRE DE SUPPORT DU CANADA

3510 Boul. St-Joseph Est
Montréal, Québec, Canada
H1X 1W6

www.lemarchedustore.ca